

SPAREPARTSCATALOG
ENGINE
ART.-NR.: 3CM089392NEN

FE 350 2014

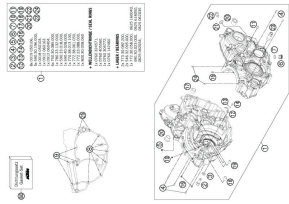

ENGINE CASE



3

CLUTCH COVER

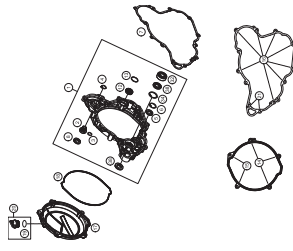

4

CYLINDER

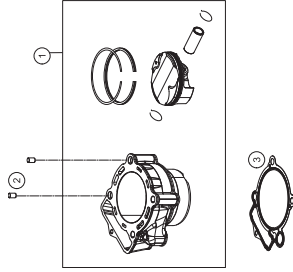

5

CRANKSHAFT, PISTON

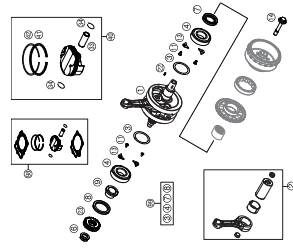

6

CLUTCH

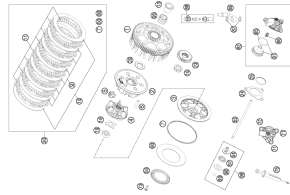

7

TRANSMISSION I - MAIN SHAFT

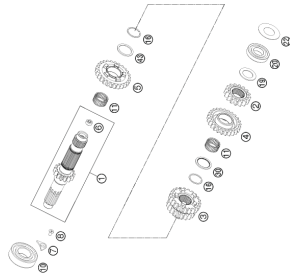

9

TRANSMISSION II - COUNTERSHAFT

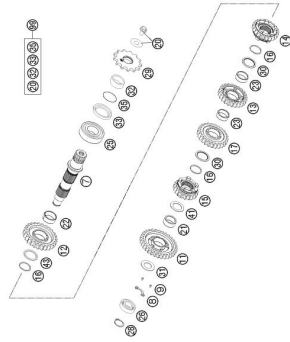

10

SHIFTING MECHANISM

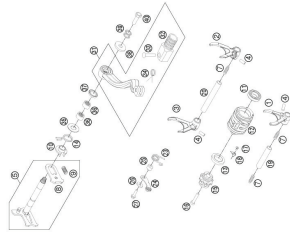

11

COOLING SYSTEM

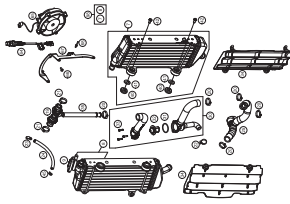

12

VALVE DRIVE

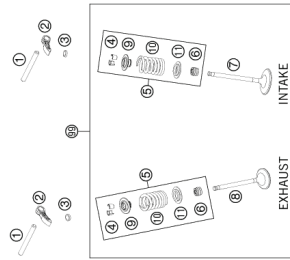

13

TIMING DRIVE

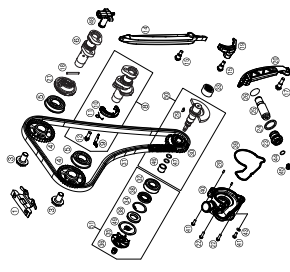

14

CYLINDER HEAD

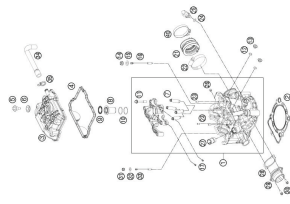

16

LUBRICATING SYSTEM

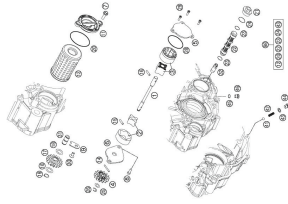

17

IGNITION SYSTEM

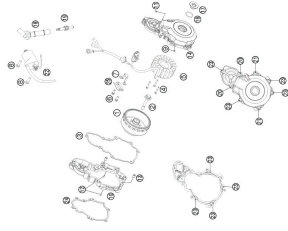

18

ELECTRIC STARTER

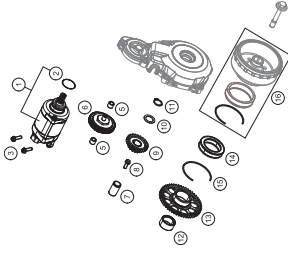

19

THROTTLE BODY

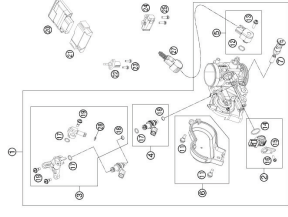

20

All information contained is without obligation. HUSQVARNA MOTORCYCLES GmbH particularly reserves the right to modify any equipment, technical specifications, prices, colors, shapes, materials, services, service work, constructions, equipment and the like so as to adapt them to local conditions or to cancel any of the above items, all without previous announcement and without giving reasons. KTM may stop manufacturing certain models without previous notice. HUSQVARNA MOTORCYCLES shall not be held liable for any deviations of availability and/or ability to deliver, illustrations, descriptions, printing and/or other errors. The illustrated models partly contain extra equipment, which is not applied to standard models.



© by HUSQVARNA MOTORCYCLES GmbH, Mattighofen AUSTRIA; All rights reserved; Reprint, also in extracts, with written allowance of HUSQVARNA MOTORCYCLES GmbH, Mattighofen only.

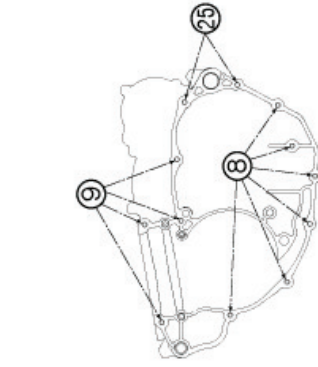

- ② ③ ④ ⑤ ⑥ ⑦ ⑨ ⑩ ⑪
 - ⑫ ⑬ ⑭ ⑮ ⑯ ⑰ ⑱ ⑲
 - ⑳ ㉑ ㉒ ㉓ ㉔
- 8x 0019 050106,
5x 590.30.196.000,
1x 0018 050103,
1x 0912 060163
1x 0912 060404,
6x 750.30.085.000,
1x 780.33.132.000,
1x 590.33.018.000,
1x 590.40.028.000,
1x 770.38.013.100,
1x 772.38.061.050,
1x 772.33.088.000,
1x 800.30.058.060
- + WELLENDICHTRINGE / SEAL RINGS**
1x 0760 324571,
1x 0760 405560,
1x 0760 304772,
1x 0760 142460
- + LAGER / BEARINGS**
2x 773.30.082.200,
2x 546.32.095.000,
1x 772.30.058.000,
490.30.023.000; 0625 160040,
0625 618050,
0625 062054, 0625 062035

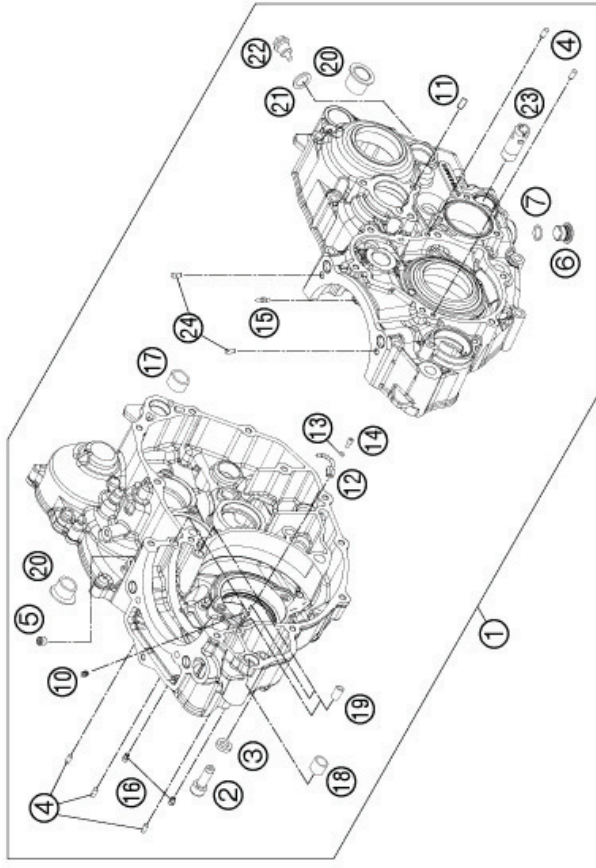

POS	PARTNUMBER	PARTNAME	PIECE
1	77730000044	ENGINE CASE CPL.	1
2	58030080000	LOCATING SCREW M8 L=23	1
3	58030081000	CU-SEAL RING 8 X 14 X 3	1
4	0402040980	NEEDLE ROL.DIN5402 NRB 4X9,8	5
5	0906100100	PLUG DIN0906-M10X1	1
6	78036081000	HOLDING BOLT M14X1,5	1
7	0770110015	O-RING 1,5x11 SILICON	1
8	0025060556	HH COLLAR SCREW M6X55 TX30	6
9	0025060656	HH COLLAR SCREW M6X65 TX30	4
10	80030058060	OIL JET "60" M4	1
11	77230066000	THRITTLE M5X10X0,5	1
12	77830064050	OIL JET CURVED " 50 "	1
13	0770035020	O-RING 3,5X2,00 NBR	1
14	0912040103	AH.SCREW DIN0912-M 4X10	1
15	60030063050	OIL JET 50 05	1
16	59030058000	JET 100 BING(44-031/180) M4	2
17	59030024000	DOWEL 17 X 19 X 12	1
18	54630027000	DOWEL BUSHING 13,8X11X12	1
19	59030023000	DOWEL 6X8X11,5	3
20	75030010100	CASE BUSH	2
21	58038022000	CU-SEAL RING DIN7603-12X18X1,5	1
22	58030021000	OILDRAIN PLUG W.MAG. M 12X1,5	1
23	77038022000	OIL INTAKEPIPE	1
24	0402050080	CYLINDER ROLLER ZR0 5X8	2
25	0025060856	HH COLLAR SCREW M6X85 TX30	2
60	77230099000	GASKET SET 350 SX-F	1

137753010

C:148133010

* NEW PART

X ON DEMAND

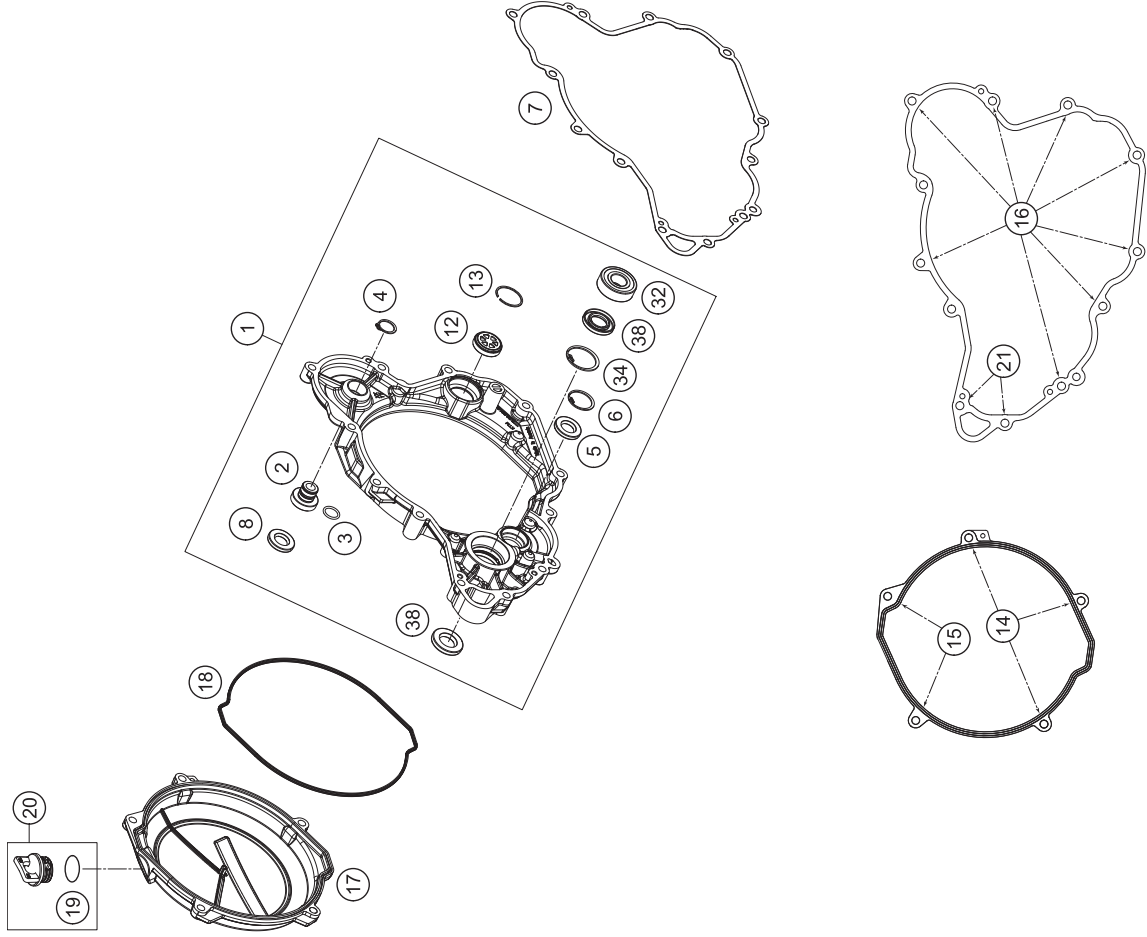

POS	PARTNUMBER	PARTNAME	PIECE
1	77230001144	CLUTCH COVER CPL.	1
2	77230001010	PLUG STARTING LEVER	1
3	0770140200	O-RING 14,00X2,00	1
4	0471170010	CIRCLIP DIN0471-17X1	1
5	0760142450	SHAFT SEAL RING 14X24X5 VITON	1
6	0472024120	CIRCLIP DIN0472-24X1.2	1
7	77230025000	CLUTCH COVER GASKET	1
8	0760172870	SHAFT SEAL RING 17X28X7 B	1
12	59030019100	OIL LEVEL GLASS	1
13	61030019050	CIRCLIP OIL LEVEL GLASS 03	1
14	0025060206	HH COLLAR SCREW M6X20 TX30	3
15	0025060456	HH COLLAR SCREW M6X45 TX30	2
16	0025060256	HH COLLAR SCREW M6X25 TX30	8
17	77230626000KA	OUTER CLUTCH COVER "HQV"	1
18	77230027000	GASKET FOR OUTER CLUTCH COVER	1
19	0770191015	O-RING 19,00X3,00 NBR	1
20	58030120000	OIL FILLER CAP M24x3 WITH O-R	1
21	0025060406	HH COLLAR SCREW M6X40 TX30	2
32	0625062022	BALL BEARING 6202 C0 2	1
34	0472300120	CIRCLIP 30X1.2	1
38	07601330451	SHAFT SEAL RING 15X30X4.5 BAUD	2

147753020

C148133022

* NEW PART

X ON DEMAND

POS	PARTNUMBER	PARTNAME	PIECE
1	77230138200	CYLINDER + PISTON	1
2	58530014100	DOWEL BUSHING 10,2X12,5X10	2
3	77230035000	CYLINDER BASE GASKET	1

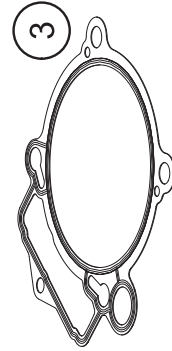
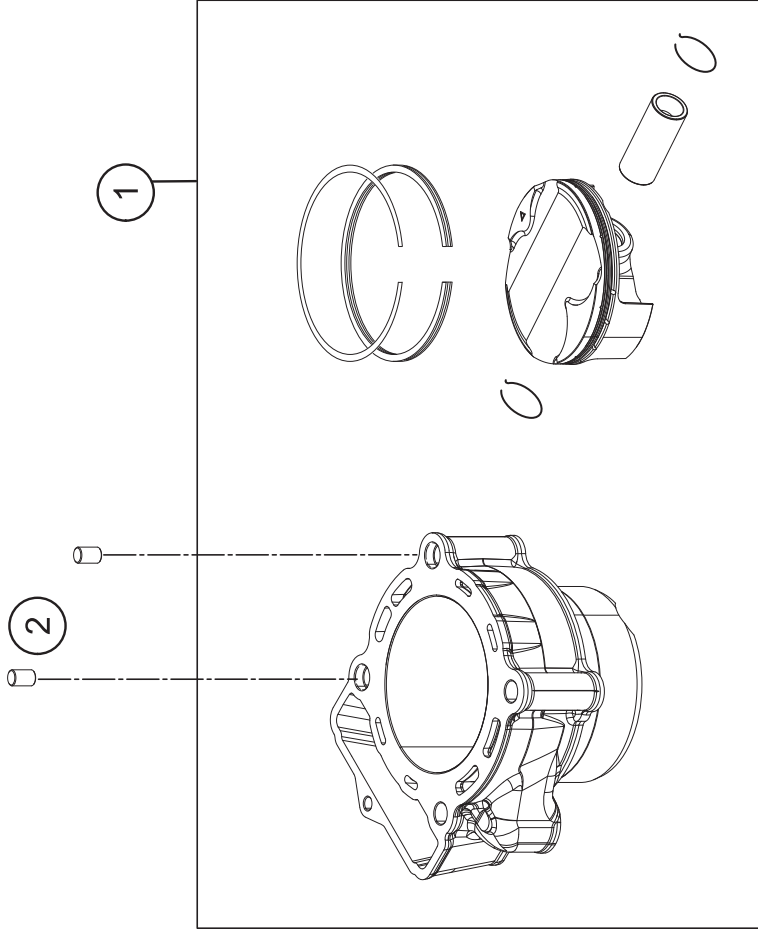

147753040

C148133040

* NEW PART

X ON DEMAND

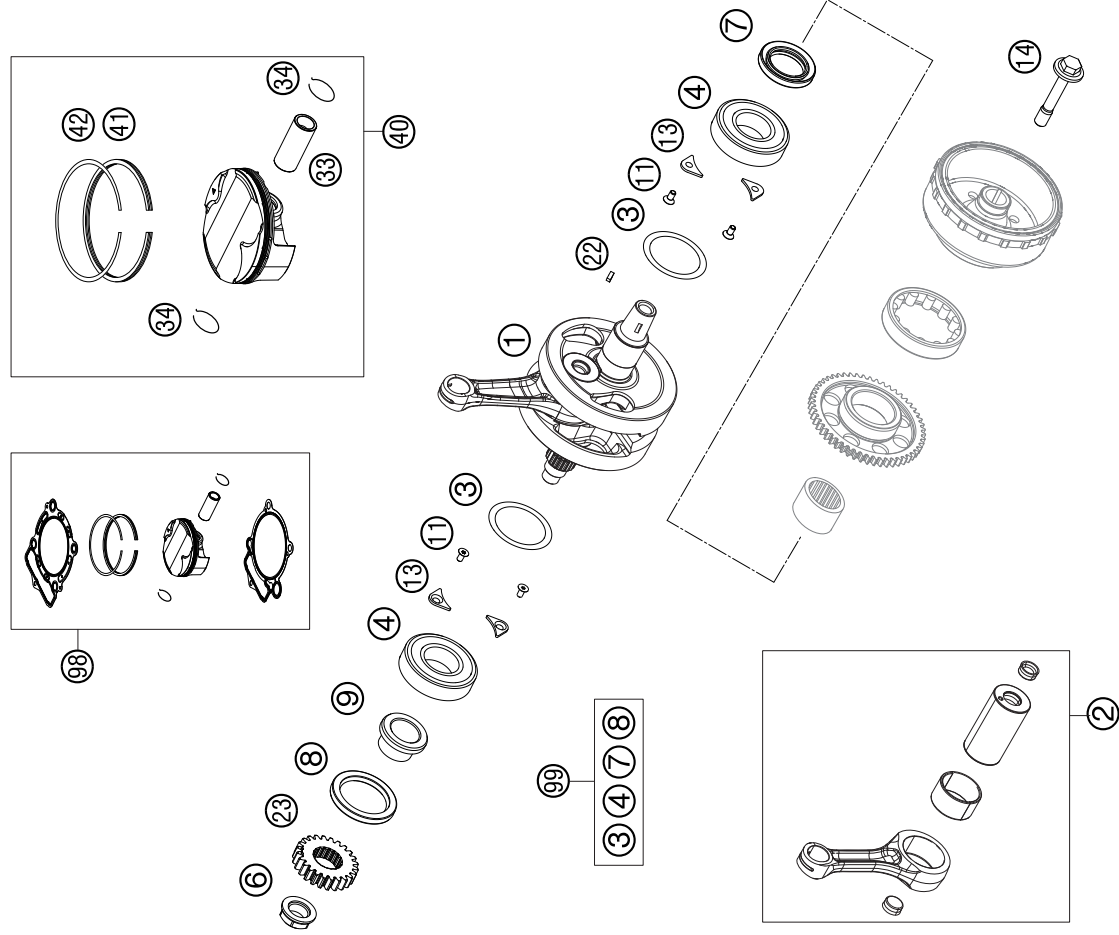

POS	PARTNUMBER	PARTNAME	PIECE
1	77530018200	CRANKSHAFT CPL.	1
2	77830015044	CONNECTING ROD REPAIR SET	1
3	0988324510	THRUST WASHER 988ST 32X0,1	x
3	0988324515	THRUST WASHER 988ST 32X0,15	x
3	0988324530	THRUST WASHER 988ST 32X0,30	x
4	77330082200	BEARING NJ 206 ECP/HN3C4HVA624	2
6	77230029000	NUT PRIMARY WHEEL	1
7	0760304772	SH.SEAL RING 30X47X7 BSL VITON	1
8	0760405560	SHAFT SEAL RING A40x55x6 VITON	1
9	77232022000	SPACER BUSHING PRIMARY GEAR	1
11	0019050106S	INT. TORX FLAT HEAD M5X10 10.9	4
13	75030085000	RETAINING PLATE F. CS BEARING	4
14	77339010100	FLYWHEEL SCREW	1
22	0888030037	WOODRUFF KEY DIN6888-3X3,7	1
23	77232023024	PRIMARY GEAR 24T.	1
33	77230133000	PISTON PIN 350	1
34	77230174000	CIRCLIP	2
40	77530107100 I	PISTON I CPL. 350	x
40	77530107100 II	PISTON II CPL. 350	x
41	77230032100	SCRAPER RING 350	1
42	77230030000	COMPRESSIONRING 350	1
98	77530007010 I	PISTON KIT GR. I 350 EXC-F 14	x
98	77530007010 II	PISTON KIT GR. II 350 EXC-F 14	x
99	00050002311	CRANKSHAFT REP. KIT SX-F 13-14	x

147753060

C148133061

* NEW PART

X ON DEMAND

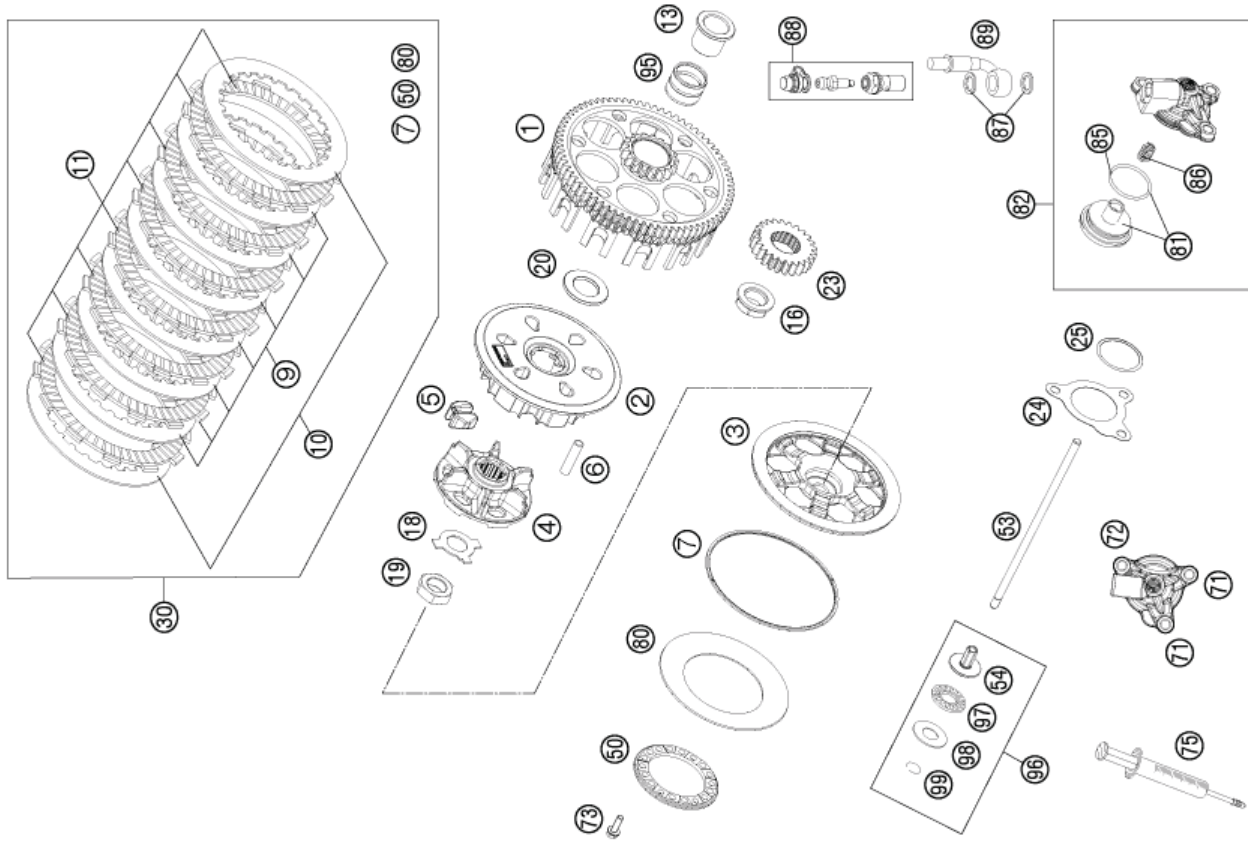

POS	PARTNUMBER	PARTNAME	PIECE
1	77232001073	OUTER CLUTCH CPL.	1
2	78132002200	INNER CLUTCH HUB 450SX-F 2014	1
3	78132003000	PRESSURE PLATE	1
4	78132002111	HUB	1
5	78132025100	DAMPING RUBBER	6
6	78132004000	SLEEVE 7,5X33,4	6
7	78132013000	WASHER 112X118X1,5	1
9	59032010200	INTERMEDIATE DISC 1,4MM 2002	7
10	59032010100	INTERMEDIATE DISC 1MM 2002	2
11	59032011100	LINING DISC 2MM 04	8
13	77232015000	INNER RING	1
16	77230029000	NUT PRIMARY WHEEL	1
18	56532018000	LOCK WASHER	1
19	0936181505	HEXAGON NUT DIN0936-M18X1,5 R.	1
20	77232009000	WASHER 21,8 X 37 X 5,1	1
23	77232023024	PRIMARY GEAR 24T.	1
24	77232062000	GASKET F. OUTPUT CYLINDER	1
25	0770300015	O-RING 30,00X1,50 NBR 70	1
30	78132010110	CLUTCH KIT 350 EXC-F 12-14	1
50	78132006100	SPRING RING	1
53	77232054000	PUSH ROD	1
54	78032057000	PRESSURE PIECE	1
71	0025060166	HH COLLAR SCREW M6X16 TX30	2
72	0025060356	HH COLLAR SCREW M6X35 TX30	1
73	0025050166	HH COLLAR SCREW M5X16 TX30	1
75	50329050000	VENT INJEKTION HYDR. CLUTCH	6
80	78132005000	BELLEVILLE SPRING 71X115X1,51	1
81	77232066000	PISTON CPL.	1
82	77232061044	OUTPUT CYLINDER CPL.	1
85	54832067000	O-RING	1
86	54832069000	PRESSURE SPRING	1
87	42013226000	CU-SEAL RING DIN7603-10X16X1	2
88	62513020000	BLEEDER SCREW CPL. 05	1
89	54832063000	CLUTCH PIPE 06	1
95	56532095000	NEEDLE BEARING K26X30X22ZWKSE	1
96	78032057044	PRESSURE PIECE CPL. 08	1
97	54637097200	AXIAL NEEDLE BEARING AXK 1226	1

C 148133211

127753210

* NEW PART

X ON DEMAND

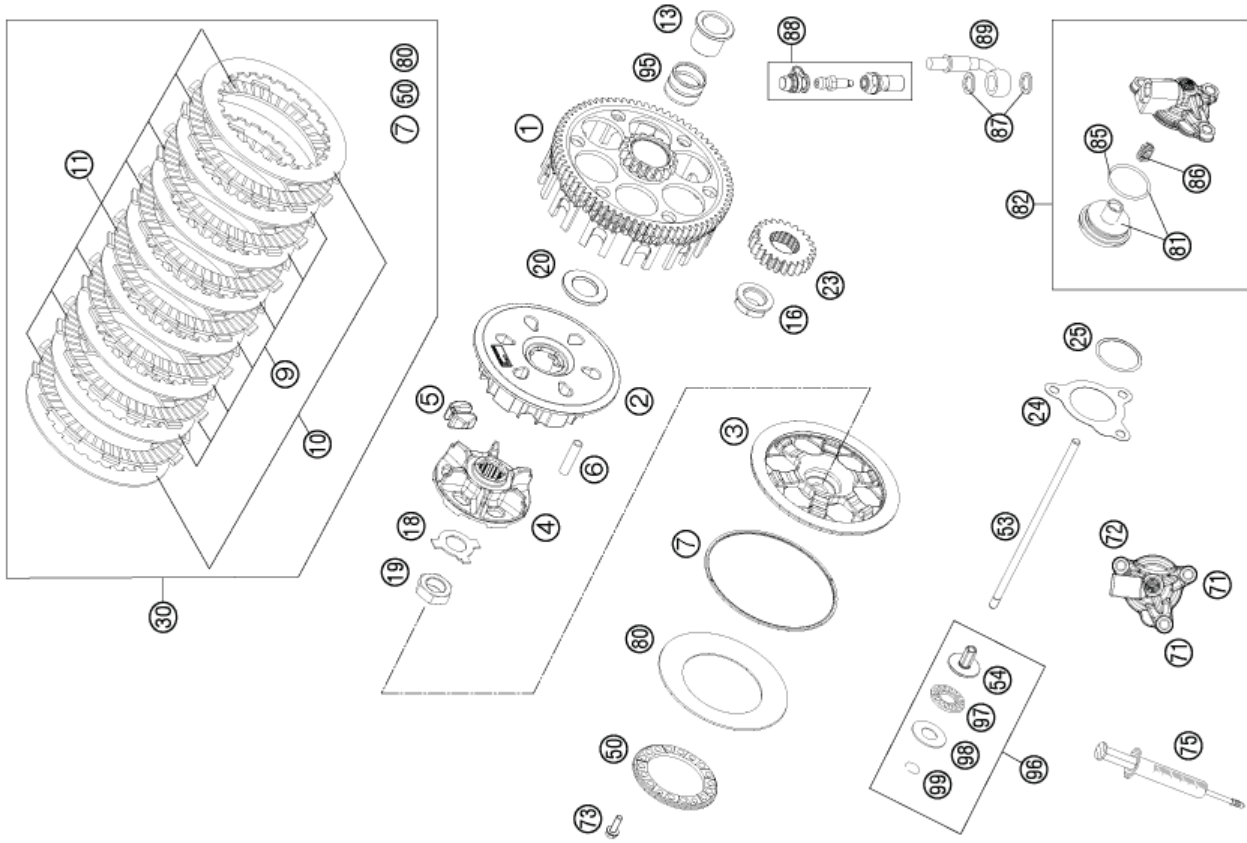

POS	PARTNUMBER	PARTNAME	PIECE
98	54637098200	AXIAL WASHER AS1226 12X26X1	1
99	0993012000	CIRCLIP DIN7993-RW12	1

127753210

C148133211

* NEW PART

X ON DEMAND

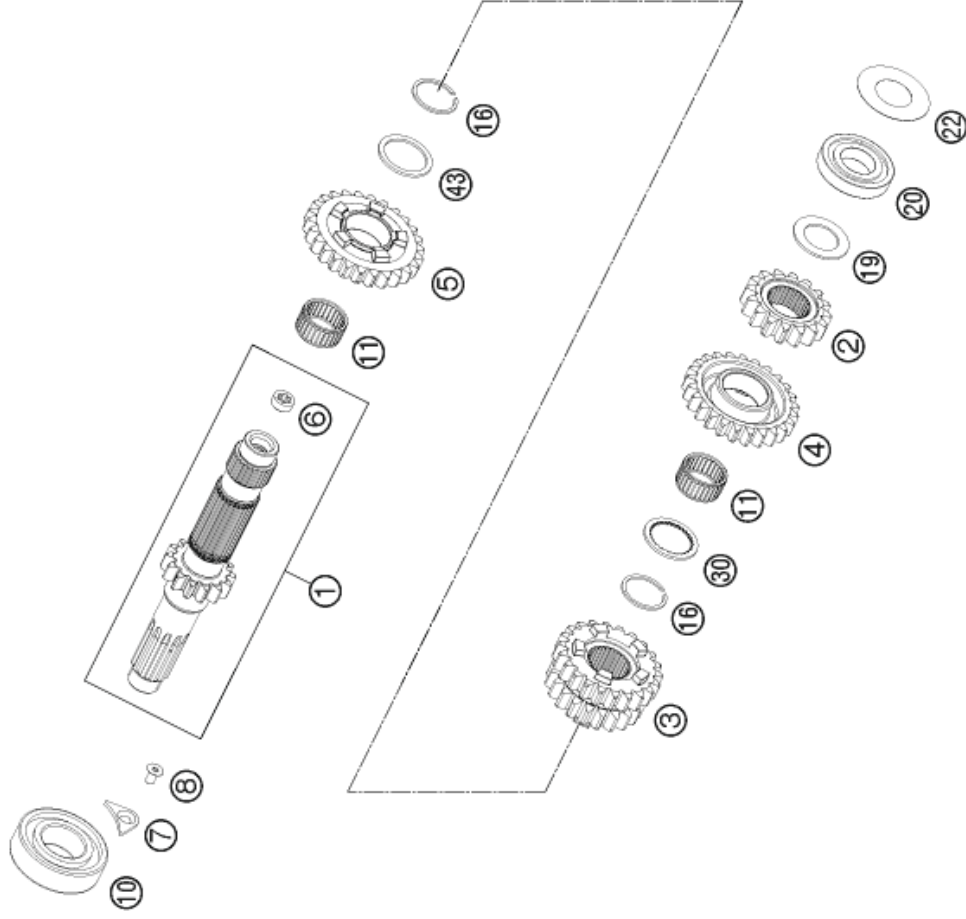

POS	PARTNUMBER	PARTNAME	PIECE
1	77233101000	MAIN SHAFT CPL. 14 T.	1
2	54833202000	SOLID GEAR	1
3	54833203000	SLIDING GEAR 3./4. GANG, Z=20/22	1
4	54833205000	IDLER GEAR 5, G, Z =25	1
5	54833206000	IDLER GEAR 6. G, Z=26	1
6	78033001110	BUSHING	1
7	75030085000	RETAINING PLATE F. CS BEARING	1
8	0019050106S	INT. TORX FLAT HEAD M5X10 10.9	1
10	0625062054	BALL BEARING 6205 C3 NTN	1
11	0405222613	NEEDLE BEAR. K 22X26X13 TN	2
16	0417024000	CIRCLIP WS24	2
19	77233015000	DISK 20,2X32X1,3	1
20	0625160040	GROOVED BALL BEAR. TM 16004 C3	1
22	77233088000	SPACER SHIM 21X42X0.2	1
30	54833043000	STOP DISC 25X0,8X30X30X7H	1
43	54833044000	STOP DISC 25X31X1,5	1

127753330

C:127753330

* NEW PART

X ON DEMAND

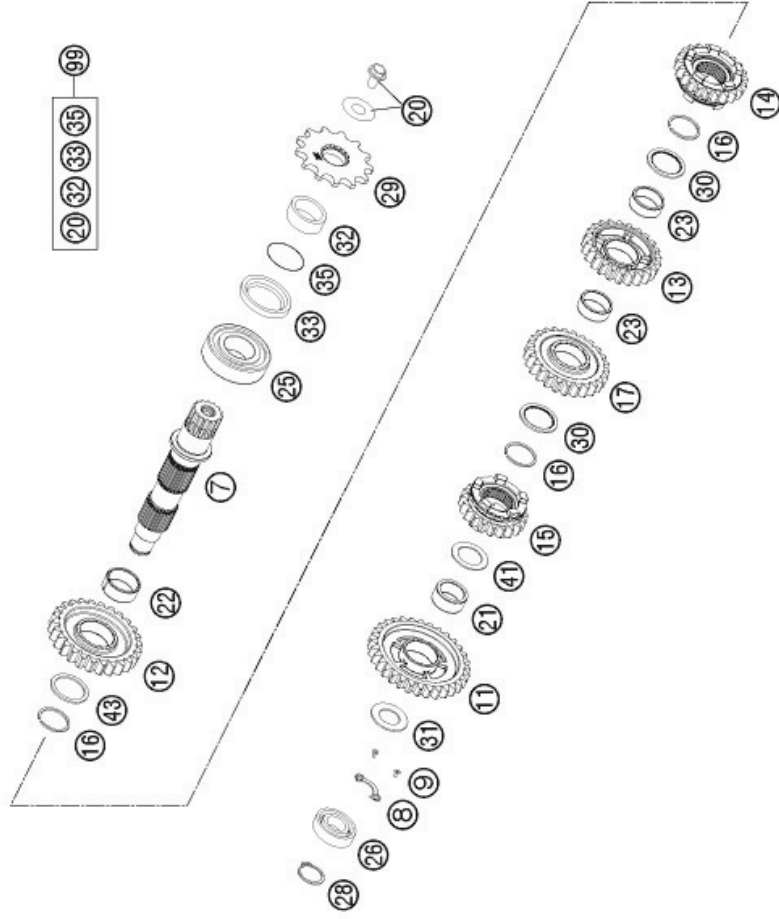

POS	PARTNUMBER	PARTNAME	PIECE
7	77233110000	COUNTERSHAFT	1
8	78033132000	TAB WASHER BEARING COUNT.SHAFT	1
9	0019050106S	INT. TORX FLAT HEAD M5X10 10.9	2
11	54833211000	IDLER GEAR 1. G., Z=32	1
12	54833212000	IDLER GEAR 2. G., Z=26	1
13	54833214000	IDLER GEAR 4.G., Z=23	1
14	54833215000	SLIDING GEAR 5.G., Z=22	1
15	54833216000	SLIDING GEAR 6.G., Z=20	1
16	0417024000	CIRCLIP WS24	3
17	54833213000	IDLER GEAR 3.G., Z= 25	1
20	59033034044	SCREW 10.9+SPRING WASHER	1
21	0405202612	NEEDLE BEARING K 20X26X12	1
22	0405242812	NEEDLE BEAR. K24X28X11,9 DIV.	1
23	0405222611	NEEDLE BEAR.K 22X26X10 DIVIDED	1
25	49030023000	CYL.ROLL BEARING NJ205	1
26	0625062035	BALL BEARING 6203 JR2 C3	1
28	0471170015	CIRCLIP DIN 0471-17X1, 5	1
29	50033029013	FRONT SPROCKET 13-T	x
29	50033029014	FRONT SPROCKET 14-T	1
30	54833043000	STOP DISC 25X0,8X30X30X7H	2
31	77233020000	STOP DISK 17,2X30X1,3	1
32	54633014100	SPACER BUSHING 12MM	1
33	0760324571	SHAFT SEAL RING 32X45X7 BSLNBR	1
35	0770020220	O-RING 25,12X1,78 NBR70	1
41	54833080000	STOP DISC 20,2X30X1	1
43	54833044000	STOP DISC 25X31X1,5	1
99	00050000941	COUNTER SHAFT REP.KIT 4 STROKE	x

12753360

C 12753360

* NEW PART

X ON DEMAND

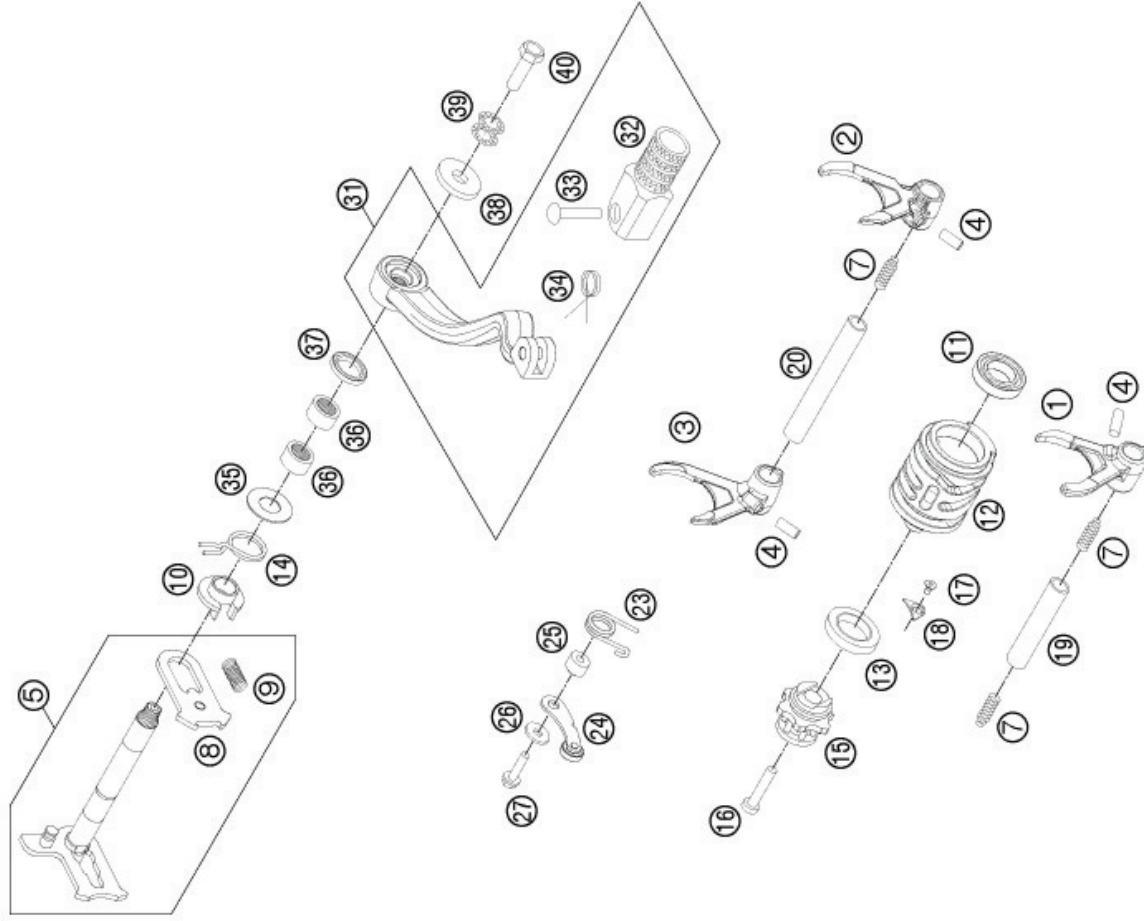

POS	PARTNUMBER	PARTNAME	PIECE
1	54834201000	SHIFT FORK 5./6.G.	1
2	54834202000	SHIFT FORK 2./4.G.	1
3	54834203000	SHIFT FORK 1./3. G.	1
4	0402061480	NEEDLE ROLLER DIN5402 6X14,8	3
5	54834005144	SHIFT SHAFT CPL.	1
7	58038023200	PRESSURE SPRING 0,9MM	3
8	54634008044	SLIDING PLATE CPL.	1
9	56534013100	TENSIONING SPRING 0,8MM	1
10	54634020000	SPRING GUIDE	1
11	0625069034	BALL BEARING 6903 C4	1
12	54834212000	SHIFTING DRUM	1
13	0625618050	BALL BEARING 61805 C3	1
14	54834014000	RETURN SPRING 03	1
15	77234015000	SHIFT LOCATING DRUM CPL.	1
16	0912060353	AH SCREW DIN0912-M 6X35	1
17	0019050106S	INT. TORX FLAT HEAD M5X10 10.9	1
18	75030085000	RETAINING PLATE F. CS BEARING	1
19	54834019000	SHIFT. RAIL MAIN SHAFT 250/300	1
20	54834020000	SHIFT. RAIL C. SHAFT 250/300	1
23	60034023000	ARRESTING LEVER SPRING 03	1
24	503334024144	LOCATING LEVER CPL. 08	1
25	54634052300	SLEEVE FOR LOCKING LEVER	1
26	0021050003	WASHER DIN9021-A 5,3	1
27	0025050206	HH COLLAR SCREW M5X20 TX30	1
31	59034031000	SHIFT LEVER CPL.RACING 2000	1
32	54634131000	STEP PLATE FOR SHIFT LEVER 250	1
33	54634031050	BOLT 6X25 FOR SHIFT LEVER	1
34	54634032100	SHIFTING LEVER SPRING 250	1
35	54634050000	STOP DISK 14X30X1	1
36	54632095000	NEEDLE BEAR.HK 1412 14X20X12	2
37	0760142460	SHAFT SEAL RING 14X24X6 B	1
38	50232050001	STEEL WASHER 6,4X17X3	1
39	50233041000	PAIR OF WASHERS M 6 NORDLOCK	1
40	59009062016	SPECIAL SCREW M6X16 WS=8 10.9	1

127753410

C:148133412

* NEW PART

X ON DEMAND

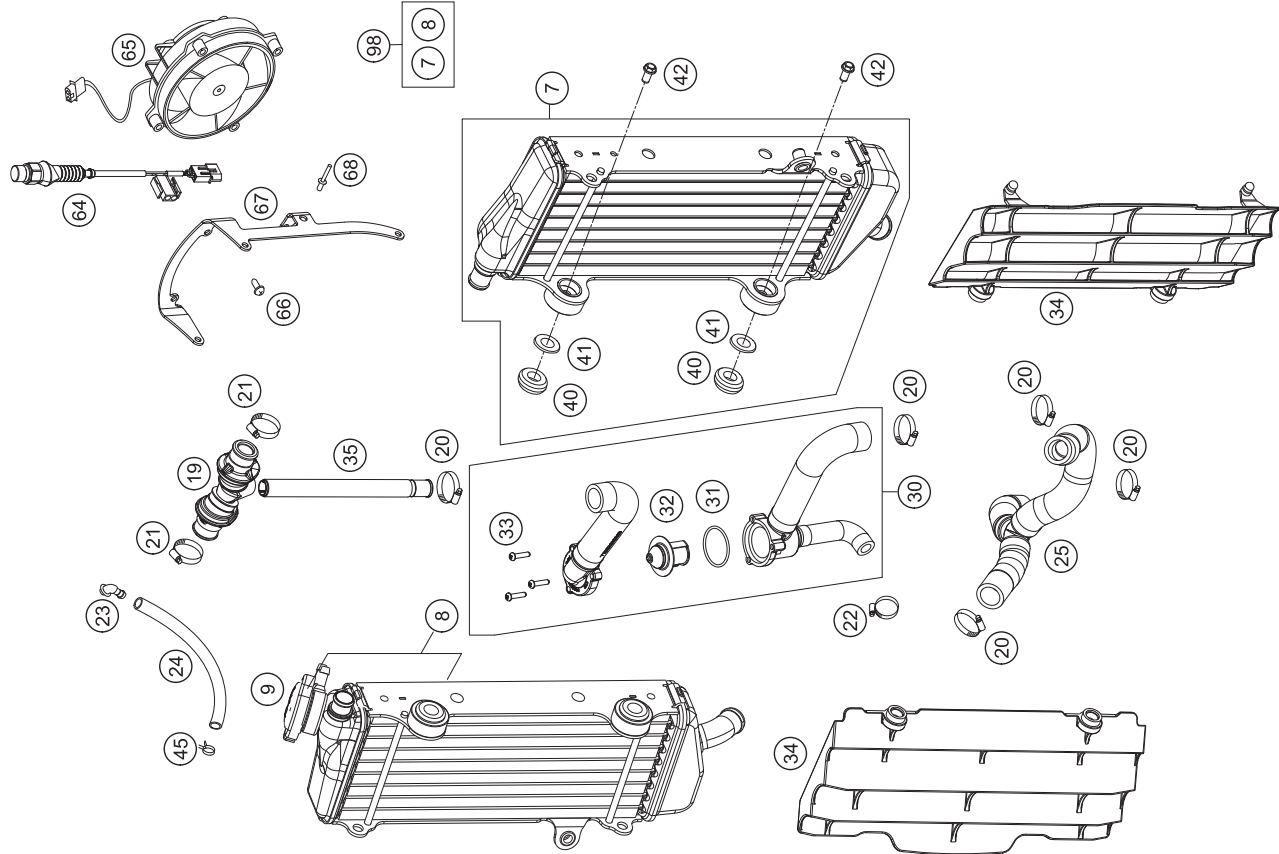

POS	PARTNUMBER	PARTNAME	PIECE
7	77035007300	RADIATOR L/S "55623U" 12	1
8	78035008100	RADIATOR R/S "55556U" 12	1
9	77335016000	RADIATOR CAP SMALL 1.8 BAR	1
19	77235071044	Y-CONNECTOR CPL.	1
20	10001020000	HOSE CLAMP GEMI 18-29	5
21	42013037400	HOSE CLAMP NORMA 12/24	2
22	58335099000	HOSE CLAMP GEMI 10-16	1
23	50303089000	ANGLE PIECE '97	1
24	50335030001	PVC-HOSE 6X9	x
25	77235025033	RADIATOR HOSE CPL.+Y-CONNECT.	1
30	77735126033	RADIATOR HOSE CPL. W. THERM.	1
31	0770320020	O-RING 32,00X2,00	1
32	59435117000	THERMOSTAT 70°C	1
33	0016040183	SCREW FOR PLASTIC D=4X18	3
34	7733503400030	RADIATOR PROTECTION BLACK 07	x
35	77235073000	HOSE CONNECTOR L=172,5	1
40	41001052000	RUBBER SLEEVE D=12MM	4
41	77335001000	WASHER FOR RADIATOR 08	4
42	0023060123	COLLAR SCREW M6X12 TX	4
45	59007017000	CLAMP YDNAC 10096F (9.6MM)	1
64	77735045000	THERMO SWITCH 95°C M14X1,5	1
65	58435041000	FAN CPL. 12V LC4 2000	1
66	0081050181	SCREW FOR PLASTIC K50X18 T20	3
67	81235943000	FAN SUPPORT	1
68	0011400800	RIVET 4,0X 8 ALU	3
98*	000500000131	RADIATOR KIT 08-14	1

C:14773533

14773530

* NEW PART

X ON DEMAND

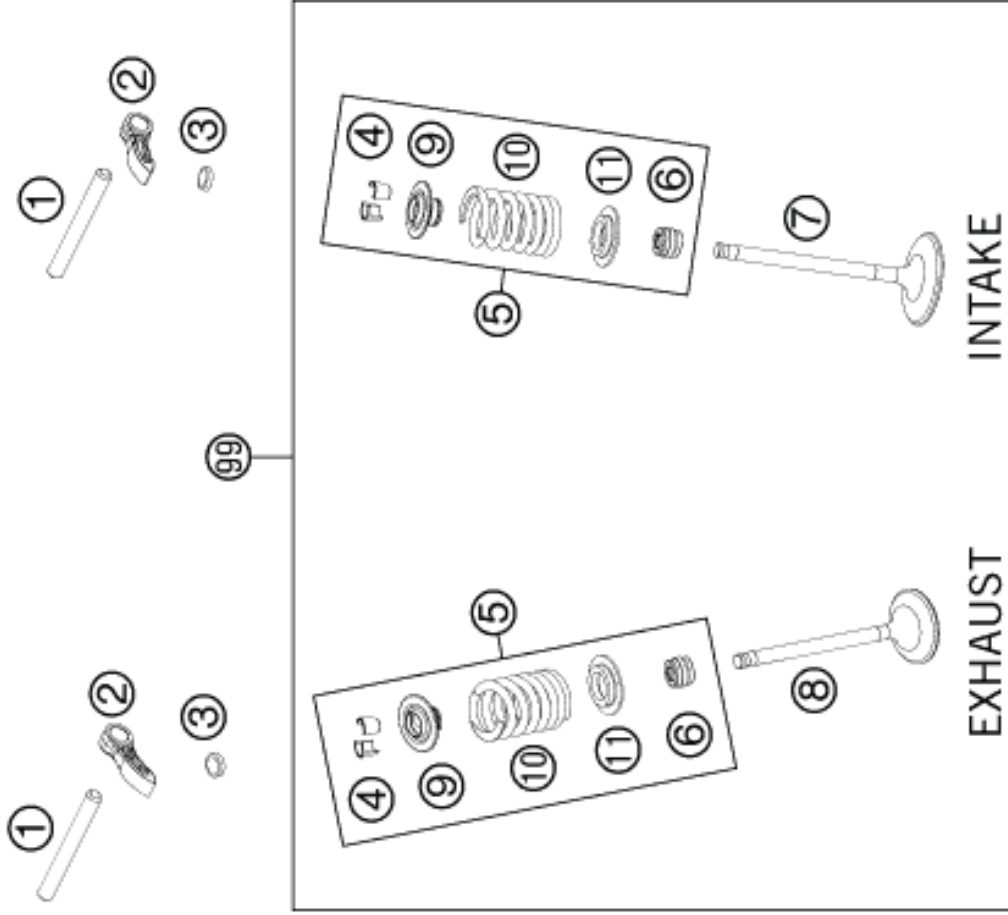

POS	PARTNUMBER	PARTNAME	PIECE
1	77236056000	VALVE LEVER SHAFT	2
2	77236060000	VALVE LEVER	4
3	77036035172	SHIM D=8,9/1,72	x
3	77036035176	SHIM D=8,9/1,76	x
3	77036035180	SHIM D=8,9/1,80	x
3	77036035184	SHIM D=8,9/1,84	x
3	77036035188	SHIM D=8,9/1,88	x
3	77036035192	SHIM D=8,9/1,92	x
3	77036035196	SHIM D=8,9/1,96	x
3	77036035200	SHIM D=8,9/2,00	x
3	77036035204	SHIM D=8,9/2,04	x
3	77036035208	SHIM D=8,9/2,08	x
3	77036035212	SHIM D=8,9/2,12	x
3	77036035216	SHIM D=8,9/2,16	x
3	77036035220	SHIM D=8,9/2,20	x
3	77036035224	SHIM D=8,9/2,24	x
3	77036035228	SHIM D=8,9/2,28	x
3	77036035232	SHIM D=8,9/2,32	x
3	77036035236	SHIM D=8,9/2,36	x
3	77036035240	SHIM D=8,9/2,40	x
3	77036035244	SHIM D=8,9/2,44	x
3	77036035248	SHIM D=8,9/2,48	x
3	77036035252	SHIM D=8,9/2,52	x
3	77036035256	SHIM D=8,9/2,56	x
3	77036035260	SHIM D=8,9/2,60	x
4	77236033000	VALVE COLLET	8
5	77536028044	VALVE SPRING KIT	4
6	77236027000	VALVE-STEM SEALING	4
7	77236030200	INTAKE VALVE	2
8	77236031100	EXHAUST VALVE	2
9	77536032100	VALVE-SPRING RETAINER	4
10	77036028300	VALVE SPRING INSIDE	4
11	77536036100	VALVE SPRING HOLDER	4
99	77536030010	VALVE KIT 350 EXC-F 12-13	1

117723610

C148133610

* NEW PART

X ON DEMAND

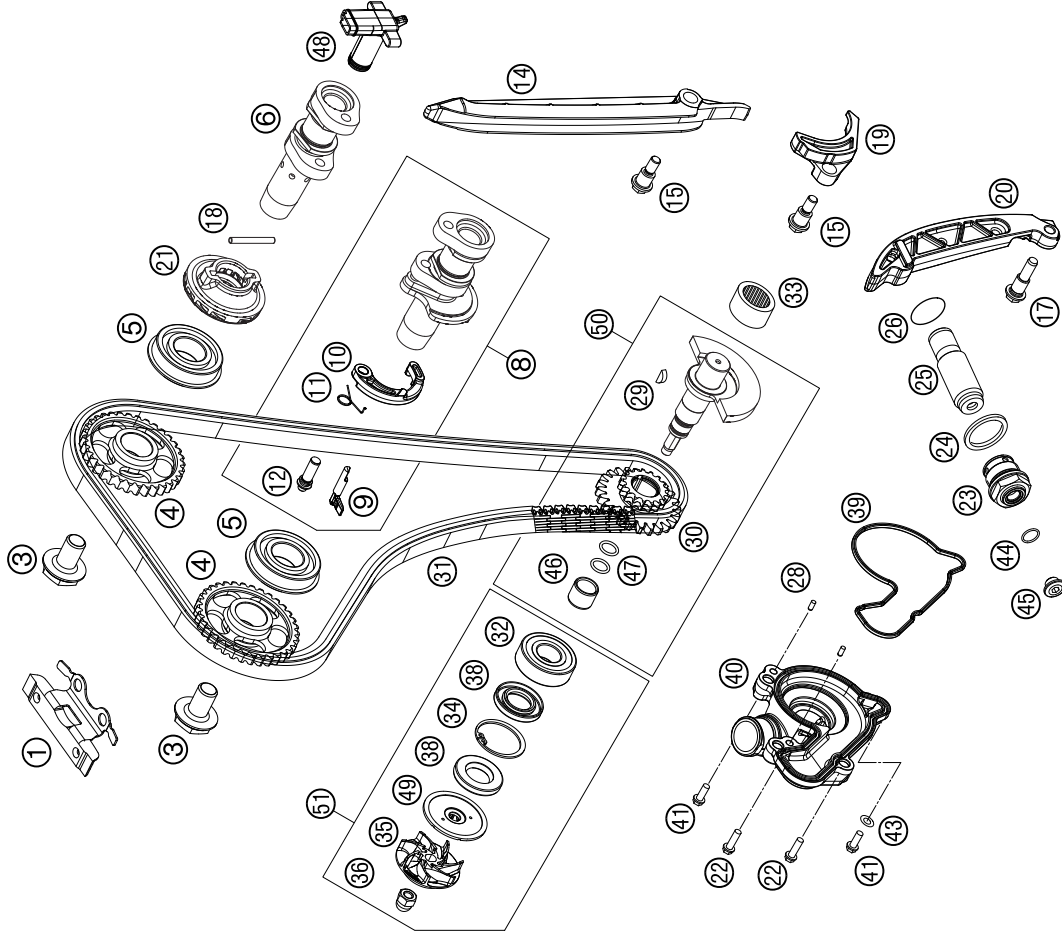

POS	PARTNUMBER	PARTNAME	PIECE
1	77236004000	TIMING CHAIN GUIDE TOP	1
3	77036012100	CAMSHAFT GEAR SCREW 08	2
4	77236011000	CAMSHAFT GEAR	2
5	0625060043	BALL BEARING 6004 NR C3 '05	2
6	77536009000	CAMSHAFT INTAKE	1
8	72036010044	CAMSHAFT EXH. WITH DEKO CPL.	1
9	77236015000	AUTO DECOMPRESSION	1
10	77036016100	AUTO DECO WEIGHT	1
11	77236017000	SPRING FOR AUTO DECOMPR.	1
12	77236019000	BUSHING SCREW AUTODEC.	1
14	77236001000	TIMING CHAIN GUIDE	1
15	77236001160	BUSHING SCREW M6	2
17	77236002160	BUSHING SCREW M8	1
18	0402035298	NEEDLE ROOLLER NRB 3.5X29.8-G2	1
19	77236005000	SECURING PROTECTION	1
20	77236002000	TENSIONING RAIL	1
21	77236082000	VENTILATION GEAR CPL.	1
22	0025060406	HH COLLAR SCREW M6X40 TX30	2
23	77336008000	HOLDING BOLT M24X1,5	1
24	0603242920	CU SEAL-RING DIN7603 A24X29X2	1
25	77036003000	CHAIN ADJUSTER HYD. 05	1
26	0770180020	O-RING 18,00X2,00 NBR 70	1
28	0402040980	NEEDLE ROL.DIN5402 NRB 4X9,8	2
29	0888030037	WOODRUFF KEY DING888-3X3,7	1
30	77236076000	TIMING VALVE TWIN WHEEL	1
31	77236013000	TIMING CHAIN	1
32	0625062022	BALL BEARING 6202 C0 2	1
33	77230058000	NEEDLE BEARING NK16/16	1
34	0472300120	CIRCLIP 30X1,2	1
35	81235055020	WATER PUMP ROTOR	1
36	61230045000	CAP NUT M6 STAINLESS STEEL	1
38	07601530451	SHAFT SEAL RING 15X30X4,5 BAUD	2
39	77735053000	WATER PUMP COVER GASKET	1
40	77735052000	WATERPUMP COVER	1
41	0025060256	HH COLLAR SCREW M6X25 TX30	2
43	0603061001	CU-SEAL RING DIN7603-6X10X1	1
44	0770010010	O-RING 10,00X1,00 NBR 70 SH	1
45	77236080000	SCREW PLUG	1

C:148133620

147753620

* NEW PART

X ON DEMAND

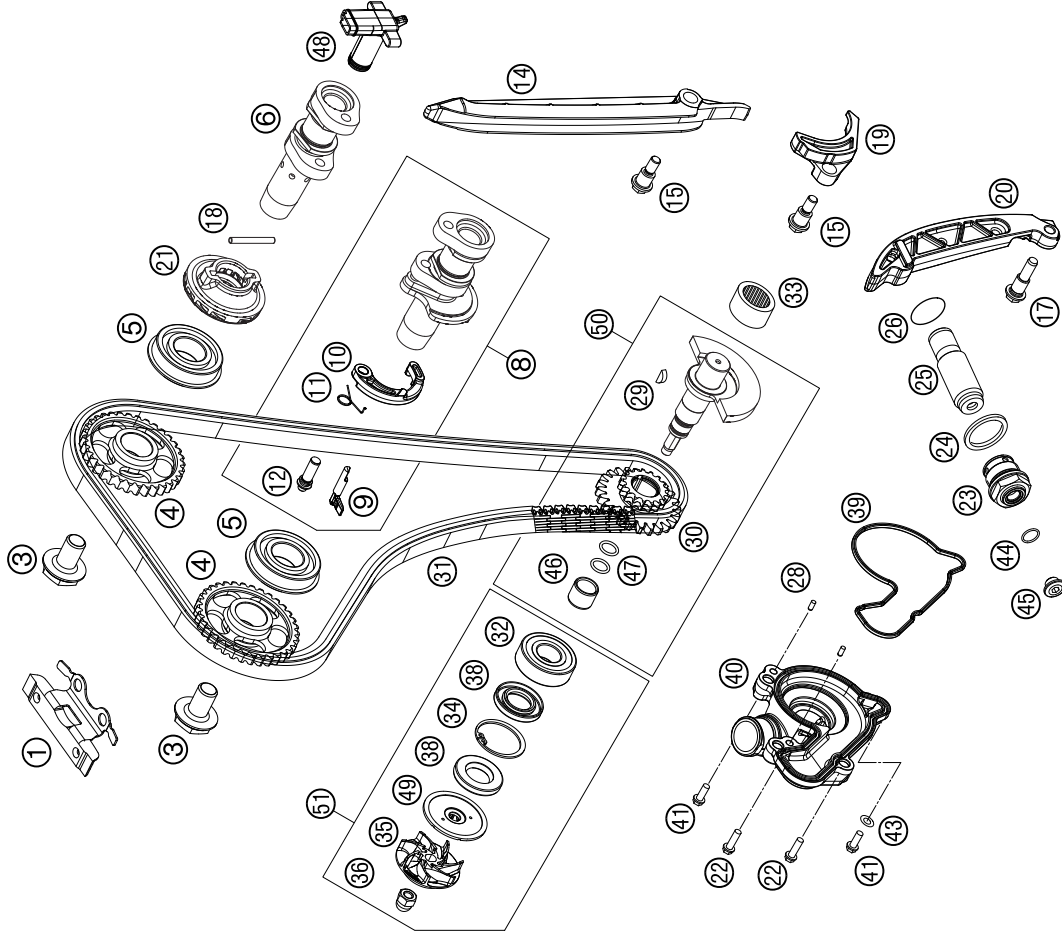

POS	PARTNUMBER	PARTNAME	PIECE
46	77236072020	WEAR BUSHING WAPU	1
47	07700900151	O-RING 9x1,5 V80 SH	2
48	77236081000	ANGLE PIECE F. BREATHER SYSTEM	1
49	81235055110	DISC WATER PUMP	1
50	77536072033	BALANCER SHAFT CPL.	x
51	77235055010	WATER PUMP REP. KIT 11-14	x

147753620

C148133620

* NEW PART

X ON DEMAND

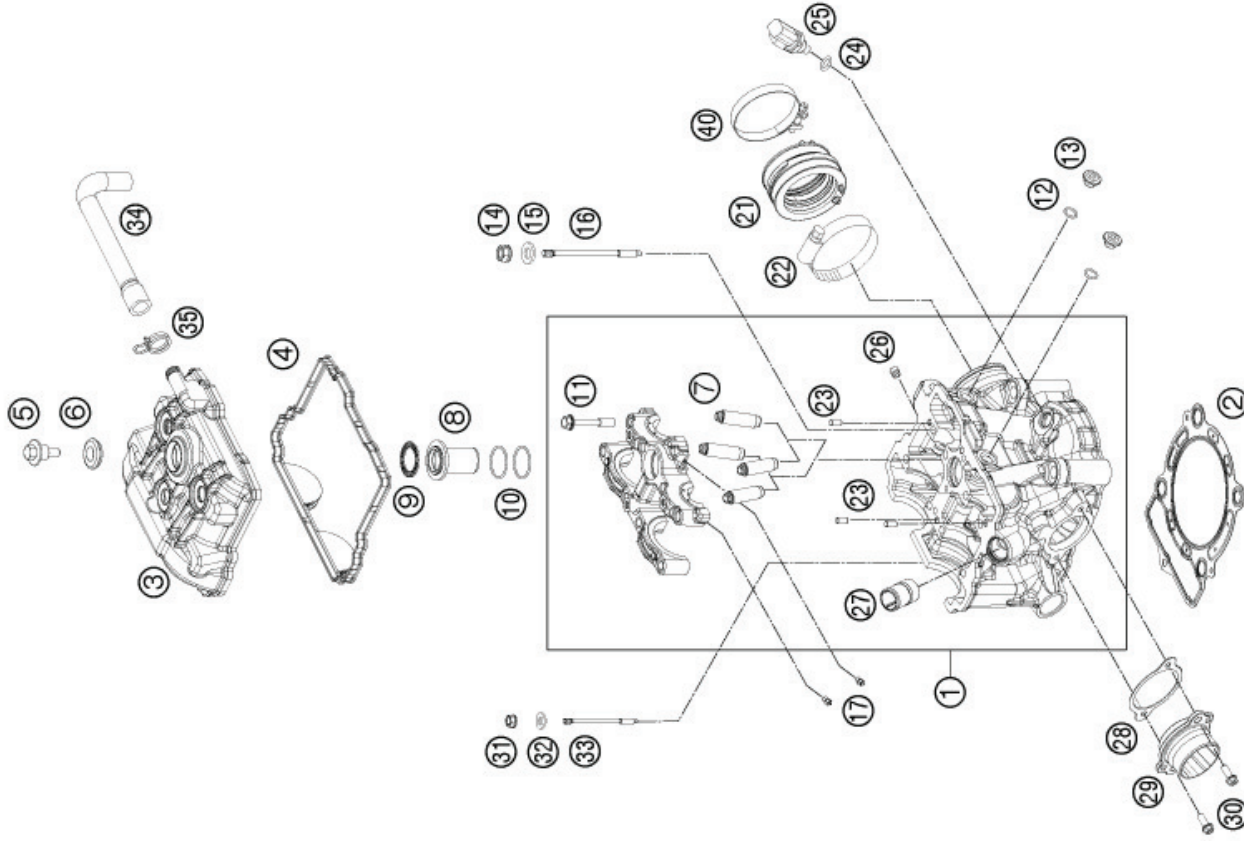

POS	PARTNUMBER	PARTNAME	PIECE
1	77236020044	CYLINDER HEAD CPL.	1
2	77230036000	CYLINDER HEAD GASKET	1
3	77236052000DA	VALVE COVER	1
4	77236053000	VALVE COVER GASKET	1
5	77336054150	VALVE COVER SCREW	3
6	77036054050	RUBBER GASKET FOR SCREW 05	3
7	77236025001	VALVE GUIDE INTAKT	4
8	77236075000	INSERT SPARK-PLUG SHAFT	1
9	77336053050	GASKET SPARK-PLUG SHAFT	1
10	0770260015	O-RING 1,5x26	2
11	77330067142	HH COLLAR SCREW M7X1X42	8
12	07700900151	O-RING 9x1,5 V80 SH	2
13	77236080000	SCREW PLUG	2
14	77336088210	COLLAR NUT M10X1,25 SW13	4
15	77336089010	WASHER 19X10,5X2,5	4
16	77230044000	STUD SCREW M10X1,25	4
17	60030063050	OIL JET 50 05	4
21	77236044000	CONNECTION RUBBER EFI	1
22	61036047000	HOSE CLAMP GEMI 63MM 05	1
23	0402050980	NEEDLE ROLLER DIN5402 5X9,8	3
24	0770100020	O-RING 10,00X2,00 SILICONE	1
25	60011252000	TEMPERAT.-SENSOR WATER LC8 02	1
26	59030296000	SCREW PLUG	1
27	58030010200	SCREW IN NOZZLE M20X1,5	1
28	77236041000	GASKET EXHAUST FLANGE	1
29	77236139000	ENGINEFLANGE	1
30	0025060166	HH COLLAR SCREW M6X16 TX30	2
31	77336088106	COLLAR NUT M6X1 SW8	1
32	0125060003	WASHER DIN0125-A 6,4	1
33	77330043000	STUD SCREW M6	1
34	77538087000	ENGINE BREATHER TUBE	1
35	58431082100	YDNAC-CLAMP 10173 (16MM) '98	1
40	77236048000	HOSE CLAMP GEMI 58MM	1

127753630

C148133633

* NEW PART

X ON DEMAND

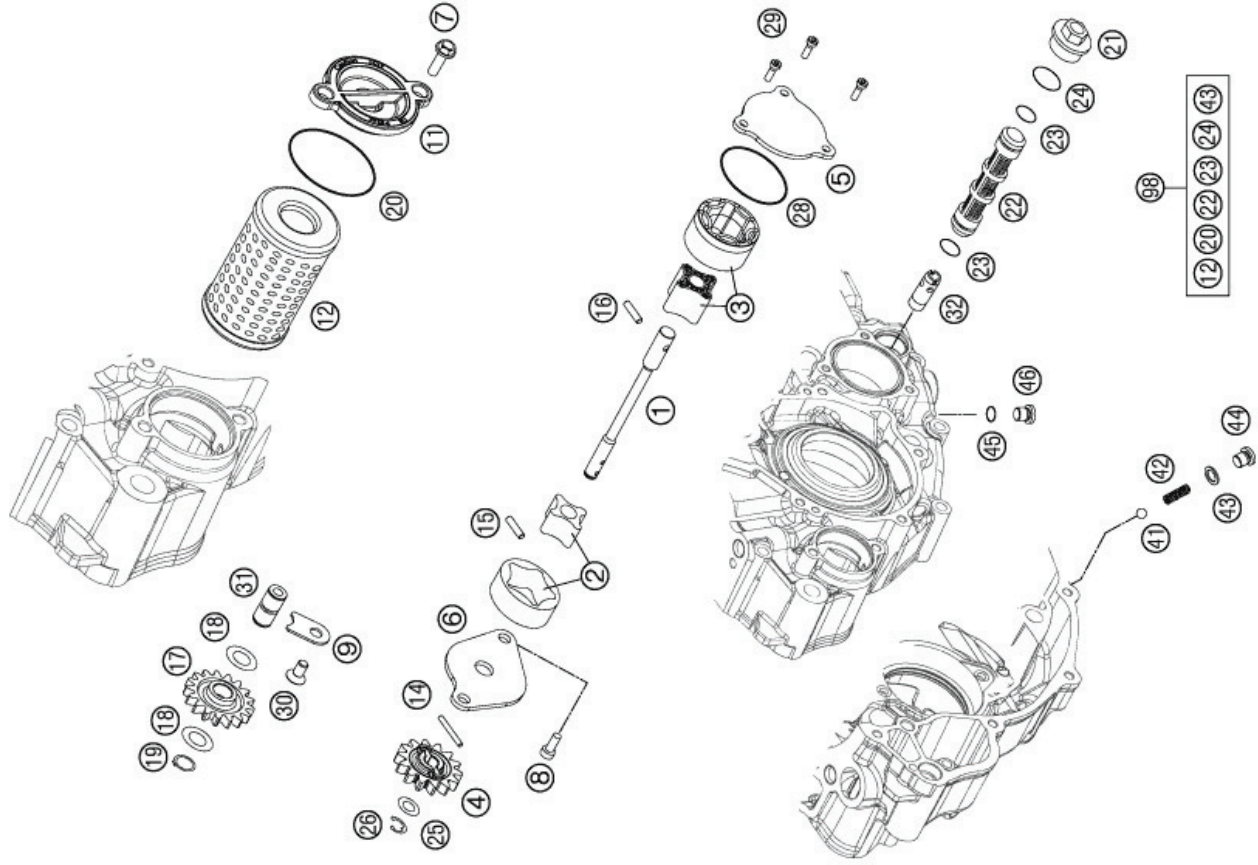

POS	PARTNUMBER	PARTNAME	PIECE
1	77238102000	OIL PUMP SHAFT	1
2	59038011112	OILPUMP ROTOR-SET 12MM CPL.	1
3	61238111000	ROTOR-SET CPL. 22MM	1
4	77038001100	OIL PUMP GEAR 14T 08	1
5	78038004000	OIL PUMP COVER SUCTION PUMP	1
6	77238003100	OIL PUMP COVER R/S	1
7	0025060166	HH COLLAR SCREW M6X16 TX30	2
8	0984050123S	CYLIND. SCR. DIN6912 M5X12 8.8	2
9	77238061050	AXIAL-CIRCLIP	1
11	77338041200	OIL FILTER COVER 08	1
12	77338005100	OIL FILTER	1
14	0402251980	NEEDLEROL.DIN5402 NRA 2,5X19,8	1
15	0402251180	NEEDLE ROLLER DIN5402 2,5X11,8	1
16	0402041580	NEEDLE ROLLER NRB 4X15,8 G2	1
17	77038006100	OILPUMP IDLER GEAR 08	1
18	0988121805	SHIM WASHER DIN0988-12X18X0,50	2
19	0471120010	CIRCLIP DIN0471-12X1	1
20	07703305178	O-RING 33,05X1,78	1
21	59038017000	PLUG M20X1,5 WS=13	1
22	59038016100	OIL SCREEN	1
23	0770125015	O-RING 12,5X1,5 NBR	2
24	0770020170	O-RING 17,17X1,78 GLO	1
25	58038007755	STOP DISK 8,1 X 15 X 0,5	1
26	0799060000	TAB WASHER DIN6799-RS 6,0	1
28	0770440020	O-RING 44,00X2,00 VITON	1
29	0984050163S	CYL. SCREW DIN6912 M5X16 8.8	3
30	0018050103	INT. TORX OVAL HEAD M 5X10 8.8	1
31	77038013100	BUSHING PIN	1
32	77038022000	OIL INTAKEPIPE	1
41	0401090003	BALL DIN5401-9	1
42	58038023300	PRESSURE SPRING L=25MM D=1MM	1
43	58038022000	CU-SEAL RING DIN7603-12X18X1,5	1
44	0908120153	PLUG DIN0908-M12X1,5	1
45	0770110015	O-RING 1,5x11 SILICON	1
46	78036081000	HOLDING BOLT M14X1,5	1
98	00050000083	OILFILTER-GASKET SET 350 SX-F	x

C:148133810

127723810

* NEW PART

X ON DEMAND

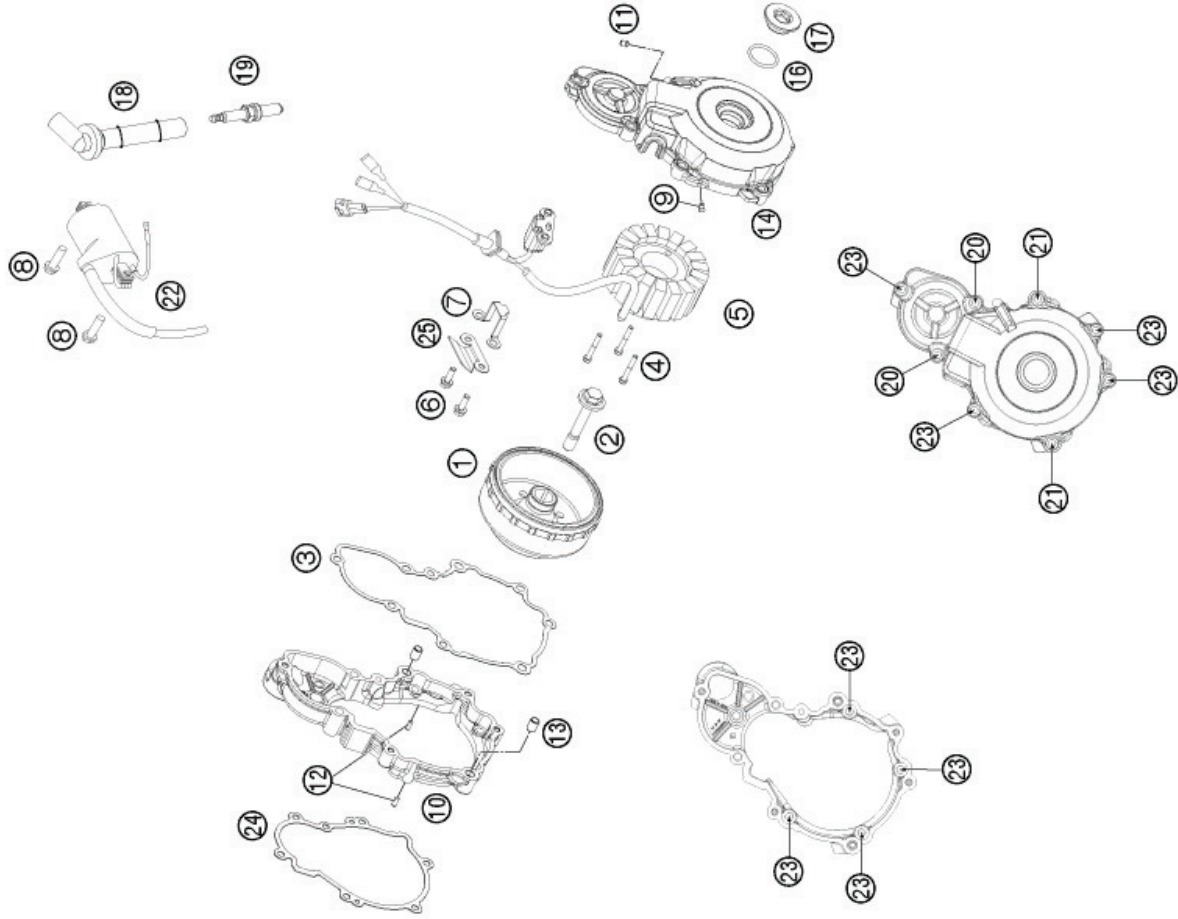

POS	PARTNUMBER	PARTNAME	PIECE
1	77539005144	ROTOR EFI CPL	1
2	77339010100	FLYWHEEL SCREW	1
3	77530042000	IGNITION COVER GASKET	1
4	0912050303	AH SCREW DIN0912-M 5X30	3
5	77539004000	STATOR	1
6	0025050166	HH COLLAR SCREW M5X16 TX30	2
7	77530002050	CABLE TAB WASHER EXC	1
8	0026060186	COLLAR SCREW M6X18 ISA30	2
9	80030058060	OIL JET "60" M4	1
10	77530002000KA	INNER IGNITION COVER	1
11	0913050063	THREAD PIN DIN 913 M5X6	1
12	0402040980	NEEDLE ROL.DIN5402 NRB 4X9,8	2
13	59030023000	DOWEL 6X8X11,5	2
14	77530012000KA	OUTER IGNITION COVER	1
16	07700240251	O-RING 24X2,5 VITON	1
17	7723000206068	IGNITION COVER PLUG M24X1,5	1
18	77239090000	SPARK PLUG CONNECTOR	1
19	77239093000	PLUG NGK LMAR9AI - 8	1
20	0025060506	HH COLLAR SCREW M6X50 TX30	2
21	0025060306	HH COLLAR SCREW M6X30 TX30	2
22	58439006000	IGNITIONCOIL IG3826 KOKUSAN'96	1
23	0025060256	HH COLLAR SCREW M6X25 TX30	8
24	77530040000	IGNITION COVER GASKET	1
25	77530002060	BRACKET	1

127753910

C148133914

* NEW PART

X ON DEMAND

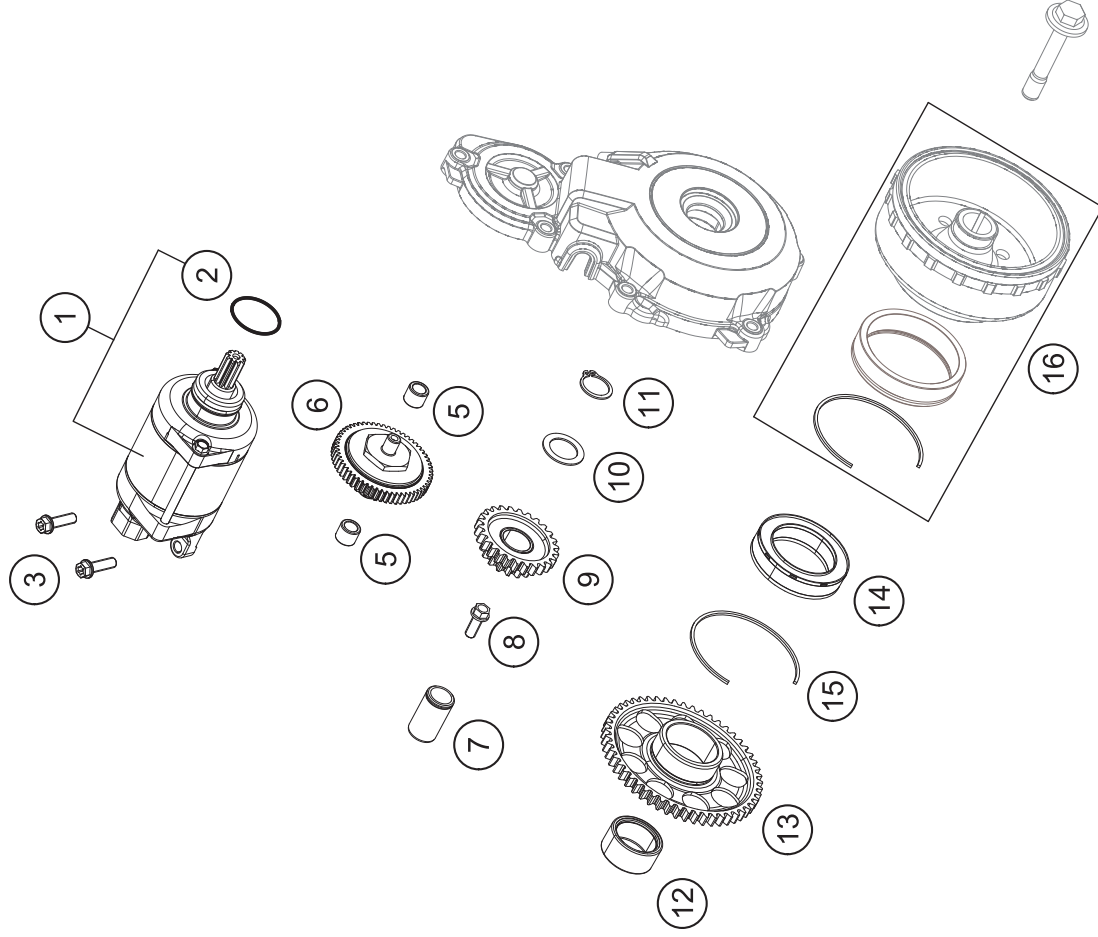

POS	PARTNUMBER	PARTNAME	PIECE
1	77240001100	E-STARTER ENGINE CPL.	1
2	0770250030	O-RING 25,00X3,00 NBR 70	1
3	0025060256	HH COLLAR SCREW M6X25 TX30	2
5	0618081210	NEEDLE BUSH HK 0810 DIN 618	2
6	77240116000	TORQUE LIMITER	1
7	59040028000	BUSHING PIN	1
8	0015060163	HH COLLAR SCREW M 6X16 WS=8	1
9	77240122000	STARTER INTERMEDIATE GEAR	1
10	54633090000	STOP DISK 17,2X25X1	1
11	0471170010	CIRCLIP DIN0471-17X1	1
12	0618253216	NEEDLE BUSH HK2516 25/32/16 02	1
13	77840120000	FREEWHEELER GEAR	1
14	80040026000	FREE WHEEL 03	1
15	0472057150	CIRCLIP DIN0472-57X1,50	1
16	77539005144	ROTOR EFI CPL.	1

147754010

C148134010

* NEW PART

X ON DEMAND

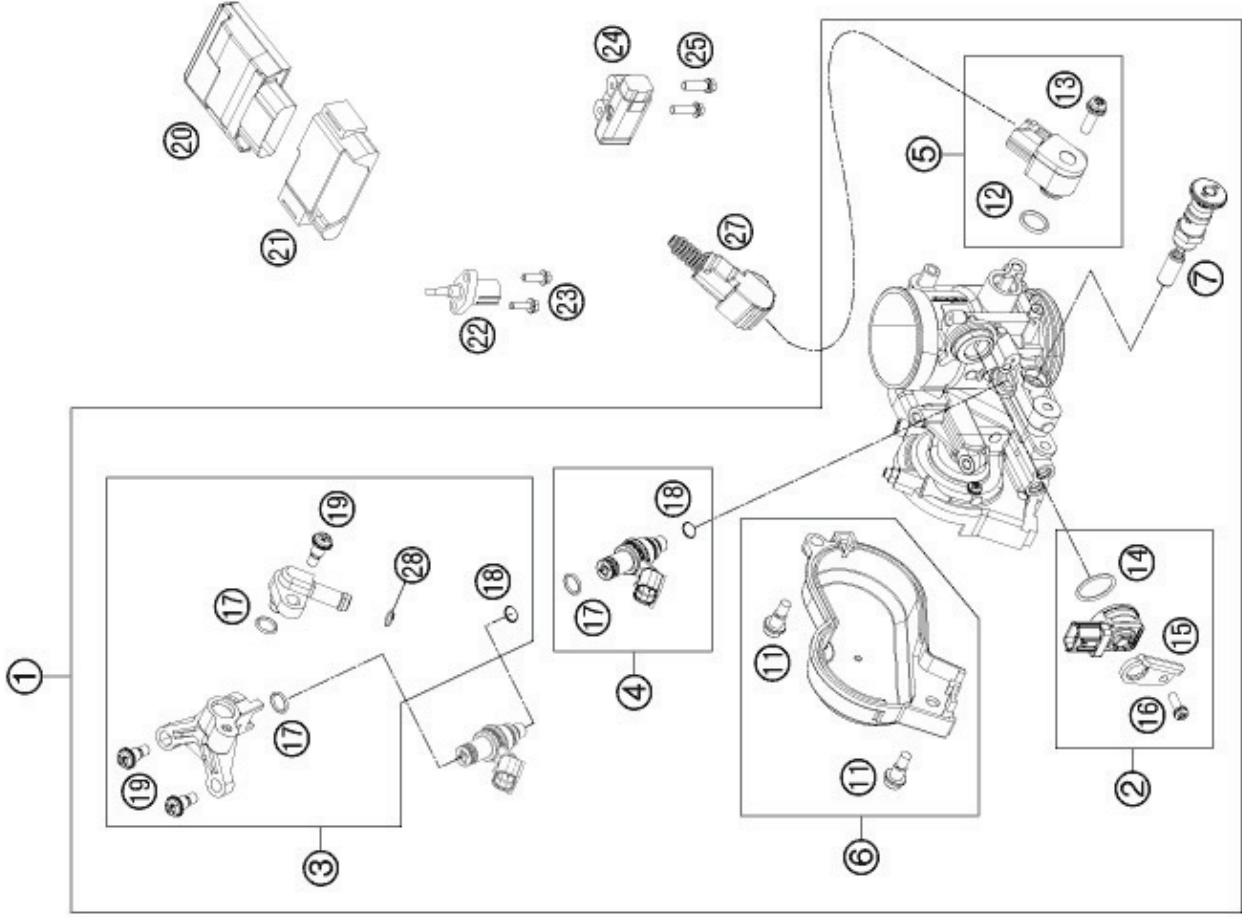

POS	PARTNUMBER	PARTNAME	PIECE
1	77241001000	THROTTLE BODY	1
2	81241085044	MAP SENSOR CPL. 09	1
3	81241013044	FUEL RAIL CPL. 09	1
4	75041023144	INJECTOR KIT CPL.	1
5	81241077044	TPS KPL. 09	1
6	81241056044	THROTTLE COVER CPL. 09	1
7	81241060000	STARTER VALVE COMP.	1
11	81241056020	SPECIAL SCREW AH	2
12	61041077010	O-RING THROTTLE POS. SENSOR	1
13	81241077030	SPECIAL SCREW	1
14	75041085010	O-RING	1
15	81241085020	PLATE 09	1
16	81241085030	SPECIAL SCREW	1
17	75041023020	O-RING 7,2x2,2	2
18	75041023010	SEAL RING	1
19	75041013010	SCREW SHOULDER	3
20	81241031100	TIMING CHARGER EFI	1
21	77241031050	RUBBER BRACKET ECU	1
22	61041080000	AMBIENT-AIR TEMPERATURE SENSOR	1
23	0025050166	HH COLLAR SCREW M5X16 TX30	2
24	61041088000	ROLLOVER SENSOR 05	1
25	0025060206	HH COLLAR SCREW M6X20 TX30	2
27	77111014050	PROTECTION CAP TPS	1
28	77507017000	CLAMP ABA 14MM	1

C137814110

137744110

* NEW PART

X ON DEMAND



3CM089392NEN



Husqvarna[®]
MOTORCYCLES

Husqvarna Motorcycles GmbH
Stallhofnerstraße 3 | 5230 Mattighofen | Austria
www.husqvarna-motorcycles.com

